

Mini Speed Dome Manual

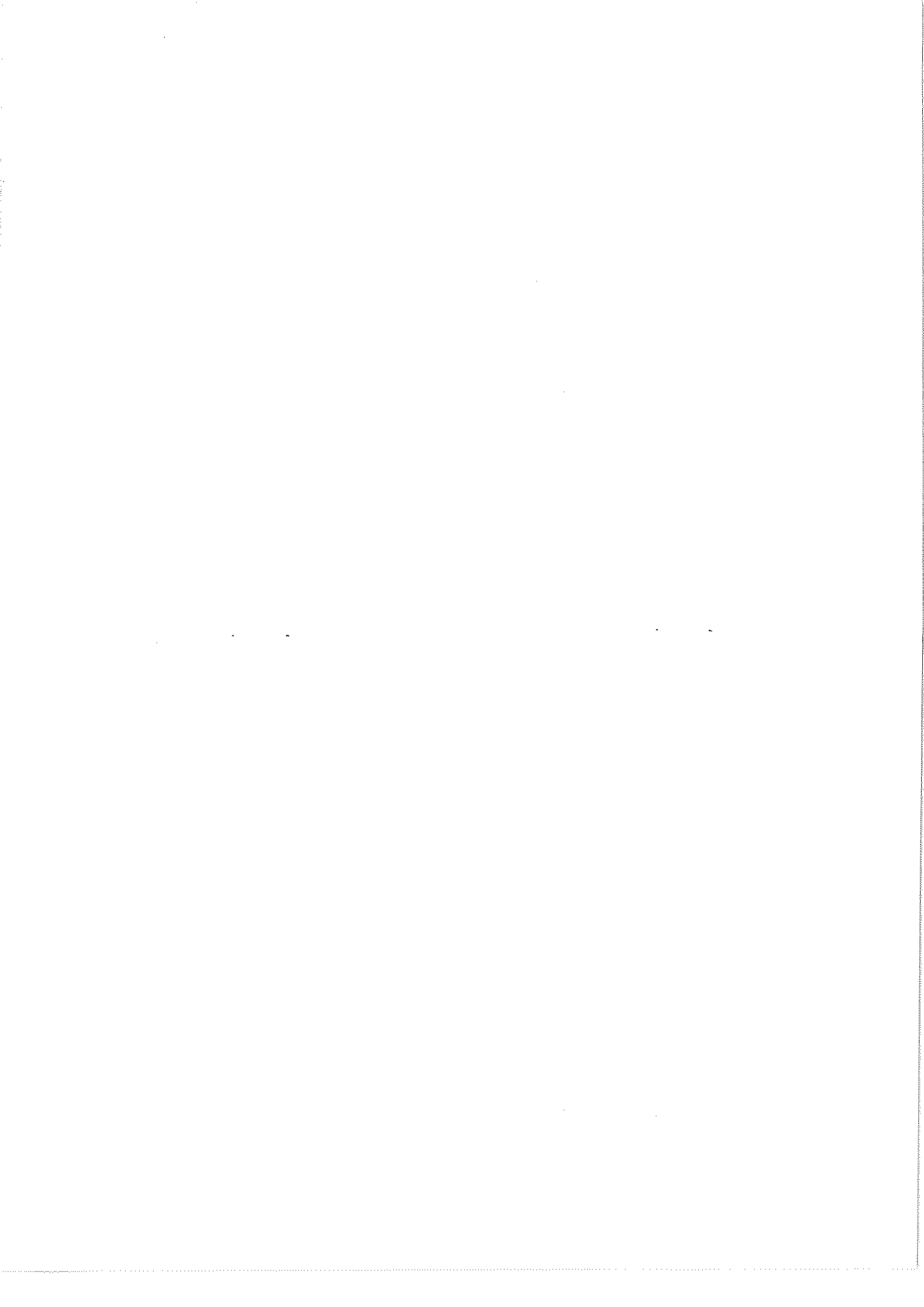

CALL+ " N" +PRESET
 SAVE+ " N" +PRESET
 CALL+ " 95" +PRESET
 CALL+ " 94" +PRESET
 CALL+ " 92" +PRESET
 CALL+ " 93" +PRESET
 CALL+ " 97" +PRESET
 CALL+ " 99" +PRESET
 CALL+ " 62" +PRESET
 CALL+ " 63" +PRESET

Show preset
 Save preset
 Enter menu
 Restart
 Set scan1 Left limit
 Set scan1 Right limit
 Run scan1
 Run pattern 1
 Open IR LED(manual state)
 Close IR LED(manual state)

TABLE OF CONTENT

1. Precaution-----	1
2. Installation Instruction-----	2
2.1 Dimension of product-----	2
2.2 Indoor dome Installation-----	2
2.2.1 Ceiling mount-----	2
2.2.2 Wall mount-----	3
2.2.3 Pendant mount-----	4
2.3 Outdoor dome Installation-----	4
2.3.1 Ceiling mount-----	4
2.3.2 Wall mount-----	5
2.3.3 Pendant mount-----	5
3. Performance-----	6
3.1 Technology parameter-----	6
3.2 Camera parameter-----	6
3.3 Performance and feature-----	7
4. Function instruction-----	8
4.1 Auto-run motion-----	8
4.2 Camera control-----	8
4.3 Monitor function-----	9
4.4 Constant temperature Function-----	9
5. System setting-----	10
5.1 Basic operation-----	10
5.1.1 Power up and self-testing-----	10
5.1.2 Call the main menu-----	10
5.1.3 Menu and keyboard operation-----	10
5.2 Edit dome title-----	11
5.3 Dome initial information-----	12
5.4 Dome ID setting-----	13
5.5 Password setup-----	14
5.6 Clock setting-----	15
5.7 System parameter-----	16
5.7.1 Power up action-----	16
5.7.2 PAN/TILT setting-----	17
5.7.3 Time action setup-----	17
5.7.4 Park action setup-----	18
5.8 Defaults-----	19
6. Camera setting-----	20
6.1 Lens parameters-----	20

6.1.1 Zoom speed-----	20
6.1.2 Digital zoom control-----	20
6.1.3 Back light compensation-----	21
6.1.4 Slow shutter control-----	22
6.1.5 WDR control-----	23
6.1.6 Day/night setting-----	24
6.2 AE mode-----	25
6.3 White balance mode-----	26
6.4 Advance parameters-----	27
6.5 Privacy zone masking-----	28
7. Function setting-----	29
7.1 Preset-----	29
7.2 Scan-----	30
7.3 Pattern-----	31
7.4 Tour-----	32
7.5 Zones-----	33
8. Display setup-----	34
9. Infrared setup-----	35
10. Appendix-----	36
10.1 Menu index-----	36
10.2 Troubleshooting-----	37
10.3 The cleaning of down cover-----	37
10.4 RS485 bus basic knowledge-----	38
10.5 DIP switch setup-----	40
10.5.1 Band rate setup-----	40
10.5.2 Protocol setup-----	40
10.5.3 ID setting-----	40
11. Maintenance service terms-----	45
12. Shortcut key-----	46

10. Maintenance

(1) Range of warranty

- The product will be maintained free for one year.
- The product will be obtained the free maintenance service if the same malfunction appears again within three months.
- Malfunction of products caused by force majeure (such as war, earthquake, lightning strike and so on), abuse, non-standard operation, change of construction, non-normal wear or accident are non-free of warranty.
- Please prevent from the damage which is caused by heavy pressure, the fierce vibration and soaks in the process of transportation and storage, which does not belong to the free maintenance scope.
- Please adopt the way of fission package or original package to transport because the product damage dose not belong to the free maintenance scope if you use the whole packing way, not the original packing way.
- The maintenance services will not be free when the pan/tilt module is disassembled or serviced by the user voluntarily.
- Our company implements the lifetime payable service if the product in malfunction has surpassed the warranty period.
- To the products with defect: if it's in the period of warranty, please fill in the form of warranty information correctly; describe the trouble in details, and provide the trouble in details, and provide original sales invoice or its copy.
- For the damage and loss which was caused by the user's specifically application, factory won't bear any risk and responsibility. The factory compensation made by breach of faith, negligence or tortious won't exceed the amount of the products. The factory won't bear any responsibility for the special, unexpected and continue damage caused by any other reasons.
- Our company has the final right of explanation for the above terms.

(2) Warranty terms

If the products are within the warranty time, the buyer should fill in the warranty card and send back together with the products.

(3) Shipping

If the product needs repaired, you can return it to the manufacturer through the supplier or directly. If you choose the later, please contact us in order to speed up the process. And our company only undertake the one-way freight from manufacturer to customer after maintenance.

ID	Switch number (Sw1)								ID	Switch number (Sw2)							
	(Bit) 2	3	4	5	6	7	8	(Bit) 2		3	4	5	6	7	8		
204	0	0	1	1	0	0	1	1	238	0	1	1	1	0	1	1	1
205	1	0	1	1	0	0	1	1	239	1	1	1	1	0	1	1	1
206	0	1	1	1	0	0	1	1	240	0	0	0	0	1	1	1	1
207	1	1	1	1	0	0	1	1	241	1	0	0	0	1	1	1	1
208	0	0	0	0	1	0	1	1	242	0	1	0	0	1	1	1	1
209	1	0	0	0	1	0	1	1	243	1	1	0	0	1	1	1	1
210	0	1	0	0	1	0	1	1	244	0	0	1	0	1	1	1	1
211	1	1	0	0	1	0	1	1	245	1	0	1	0	1	1	1	1
212	0	0	1	0	1	0	1	1	246	0	1	1	0	1	1	1	1
213	1	0	1	0	1	0	1	1	247	1	1	1	0	1	1	1	1
214	0	1	1	0	1	0	1	1	248	0	0	0	1	1	1	1	1
215	1	1	1	0	1	0	1	1	249	1	0	0	1	1	1	1	1
216	0	0	0	1	1	0	1	1	250	0	1	0	1	1	1	1	1
217	1	0	0	1	1	0	1	1	251	1	1	0	1	1	1	1	1
218	0	1	0	1	1	0	1	1	252	0	0	1	1	1	1	1	1
219	1	1	0	1	1	0	1	1	253	1	0	1	1	1	1	1	1
220	0	0	1	1	1	0	1	1	254	0	1	1	1	1	1	1	1
221	1	0	1	1	1	0	1	1	255	1	1	1	1	1	1	1	1
222	0	1	1	1	1	0	1	1									
223	1	1	1	1	1	0	1	1									
224	0	0	0	0	0	1	1	1									
225	1	0	0	0	0	1	1	1									
226	0	1	0	0	0	1	1	1									
227	1	1	0	0	0	1	1	1									
228	0	0	1	0	0	1	1	1									
229	1	0	1	0	0	1	1	1									
230	0	1	1	0	0	1	1	1									
231	1	1	1	0	0	1	1	1									
232	0	0	0	1	0	1	1	1									
233	1	0	0	1	0	1	1	1									
234	0	1	0	1	0	1	1	1									
235	1	1	0	1	0	1	1	1									
236	0	0	1	1	0	1	1	1									
237	1	0	1	1	0	1	1	1									



Notice: 1. Debug address: (Only factory protocol and Pelco can be set); if the camera address is set as 0, user can select any protocols to control the dome

2. Broadcast address(Only factory protocol and Pelco can be set); if user selects "255" to control, all the systematic connection cameras will carry our the same motions.

1. Precaution

Electrical safety

Conform to country and local electrical safety standard when using or installing the product. Using local special power adapter. This dome uses DC12V/1500mA power supply.

Transportation

The dome should be protected against extremes of pressure, vibration and humidity during storage and transportation. It should be shipped in parts disassembled as the original packing did. Damage caused by improper transportation is not within the warranty.

Installation with care

Do not install it in any other orientation. Do not squeezed structure parts, which may cause mechanical damage. Down cover is a precise optical product. Do not touch it directly to avoid scratches which can affect image quality.

Requirements to service personnel

All the service work should be done by qualified technicians.

Environmental requirements

Operation environment temperature: -10℃~+50℃

Humidity: < 90%

Air pressure: 86-106Kpa

Power supply: DC12V/1500MA

Don't place the camera to be shoot by strong light objects

Don't place the camera to be shoot by strong light objects. Don't point the dome to the sun or other bright objects when in use or not. It may affect image quality.

2. Installation instruction

2.1 Dimension of product

	Ceiling	Wall	Pendant
Indoor			
Outdoor			

2.2 Indoor Dome Installation

2.2.1 Ceiling mount

1. Drill holes and fix base board on the ceiling floor using 3pcs M4 bolts, and fix the dome with base board(Like picture 2.2.1-1, 2.2.1-2).

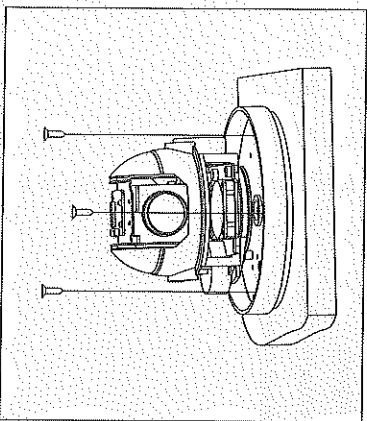

Picture 2.2.1-2

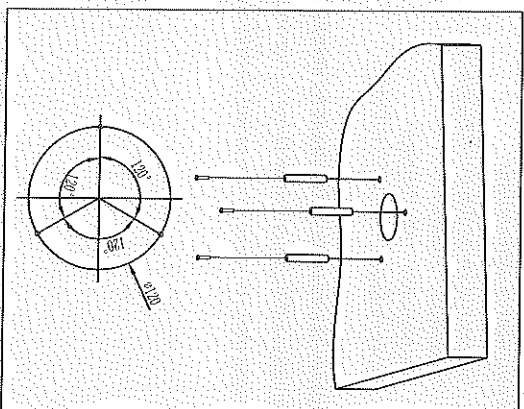

Picture 2.2.1-1

ID	Switch number (Sw)								ID	Switch number (Sw)								
	(Bit)	1	2	3	4	5	6	7		8	(Bit)	1	2	3	4	5	6	7
136	0	0	0	1	0	0	0	0	1	170	0	1	0	1	0	1	0	1
137	1	0	0	1	0	0	0	0	1	171	1	1	0	1	0	1	0	1
138	0	1	0	1	0	0	0	0	1	172	0	0	1	1	0	1	0	1
139	1	1	0	1	0	0	0	0	1	173	1	0	1	1	0	1	0	1
140	0	0	1	1	0	0	0	0	1	174	0	1	1	1	0	1	0	1
141	1	0	1	1	0	0	0	0	1	175	1	1	1	1	0	1	0	1
142	0	1	1	1	0	0	0	0	1	176	0	0	0	0	1	1	0	1
143	1	1	1	1	0	0	0	0	1	177	1	0	0	0	1	1	0	1
144	0	0	0	0	1	0	0	0	1	178	0	1	0	0	1	1	0	1
145	1	0	0	0	1	0	0	0	1	179	1	1	0	0	1	1	0	1
146	0	1	0	0	1	0	0	0	1	180	0	0	1	0	1	1	0	1
147	1	1	0	0	1	0	0	0	1	181	1	0	1	0	1	1	0	1
148	0	0	1	0	1	0	0	0	1	182	0	1	1	0	1	1	0	1
149	1	0	1	0	1	0	0	0	1	183	1	1	1	0	1	1	0	1
150	0	1	1	0	1	0	0	0	1	184	0	0	0	1	1	1	0	1
151	1	1	1	0	1	0	0	0	1	185	1	0	0	1	1	1	0	1
152	0	0	0	1	1	0	0	0	1	186	0	1	0	1	1	1	0	1
153	1	0	0	1	1	0	0	0	1	187	1	1	0	1	1	1	0	1
154	0	1	0	1	1	0	0	0	1	188	0	0	1	1	1	1	0	1
155	1	1	0	1	1	0	0	0	1	189	1	0	1	1	1	1	0	1
156	0	0	1	1	1	0	0	0	1	190	0	1	1	1	1	1	0	1
157	1	0	1	1	1	0	0	0	1	191	1	1	1	1	1	1	0	1
158	0	1	1	1	1	0	0	0	1	192	0	0	0	0	0	0	1	1
159	1	1	1	1	1	0	0	0	1	193	1	0	0	0	0	0	1	1
160	0	0	0	0	0	1	0	0	1	194	0	1	0	0	0	0	1	1
161	1	0	0	0	0	1	0	0	1	195	1	1	0	0	0	0	1	1
162	0	1	0	0	0	1	0	0	1	196	0	0	1	0	0	0	1	1
163	1	1	0	0	0	1	0	0	1	197	1	0	1	0	0	0	1	1
164	0	0	1	0	0	1	0	0	1	198	0	1	1	0	0	0	1	1
165	1	0	1	0	0	1	0	0	1	199	1	1	1	0	0	0	1	1
166	0	1	1	0	0	1	0	0	1	200	0	0	0	1	0	0	1	1
167	1	1	1	0	0	1	0	0	1	201	1	0	0	1	0	0	1	1
168	0	0	0	1	0	1	0	0	1	202	0	1	0	1	0	0	1	1
169	1	0	0	1	0	1	0	0	1	203	1	1	0	1	0	0	1	1

2. Fasten the housing with the dome, like picture 2.2.1-3. Pay attention to set the DIP switch on the pan/tilt core at first.

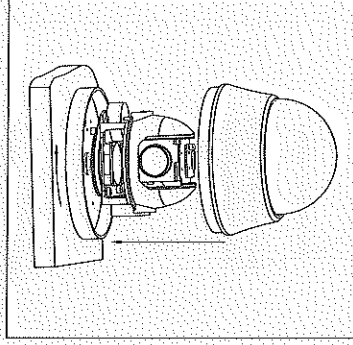

Picture 2.2.1-3

2. Take off the housing, and use 3pcs M4*20 bolts to fasten dome and board, then install the housing back.

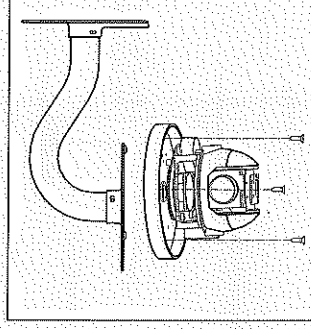

Picture 2.2.2-2

3. Connect the power line, video cable and RS485 cable. 3. Install the wall bracket to the wall by 3pcs STP4*20 bolts.

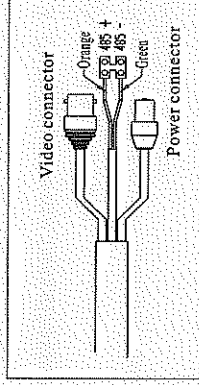

Picture 2.2.1-4

2.2.2 Wall mount

1. Assemble the three parts of wall bracket together as below shows.

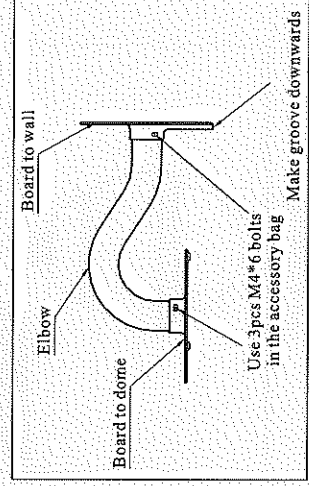

Picture 2.2.2-1

ID	Switch number (Sw1)								ID	Switch number (Sw2)							
	(Bit)1	2	3	4	5	6	7	8		(Bit)1	2	3	4	5	6	7	8
68	0	0	1	0	0	0	1	0	102	0	1	1	0	0	1	1	0
69	1	0	1	0	0	0	1	0	103	1	1	1	0	0	1	1	0
70	0	1	1	0	0	0	1	0	104	0	0	0	1	0	1	1	0
71	1	1	1	0	0	0	1	0	105	1	0	0	1	0	1	1	0
72	0	0	0	1	0	0	1	0	106	0	1	0	1	0	1	1	0
73	1	0	0	1	0	0	1	0	107	1	1	0	1	0	1	1	0
74	0	1	0	1	0	0	1	0	108	0	0	1	1	0	1	1	0
75	1	1	0	1	0	0	1	0	109	1	0	1	1	0	1	1	0
76	0	0	1	1	0	0	1	0	110	0	1	1	1	0	1	1	0
77	1	0	1	1	0	0	1	0	111	1	1	1	1	0	1	1	0
78	0	1	1	1	0	0	1	0	112	0	0	0	0	1	1	1	0
79	1	1	1	1	0	0	1	0	113	1	0	0	0	1	1	1	0
80	0	0	0	0	1	0	1	0	114	0	1	0	0	1	1	1	0
81	1	0	0	0	1	0	1	0	115	1	1	0	0	1	1	1	0
82	0	1	0	0	1	0	1	0	116	0	0	1	0	1	1	1	0
83	1	1	0	0	1	0	1	0	117	1	0	1	0	1	1	1	0
84	0	0	1	0	1	0	1	0	118	0	1	1	0	1	1	1	0
85	1	0	1	0	1	0	1	0	119	1	1	1	0	1	1	1	0
86	0	1	1	0	1	0	1	0	120	0	0	0	1	1	1	1	0
87	1	1	1	0	1	0	1	0	121	1	0	0	1	1	1	1	0
88	0	0	0	1	1	0	1	0	122	0	1	0	1	1	1	1	0
89	1	0	0	1	1	0	1	0	123	1	1	0	1	1	1	1	0
90	0	1	0	1	1	0	1	0	124	0	0	1	1	1	1	1	0
91	1	1	0	1	1	0	1	0	125	1	0	1	1	1	1	1	0
92	0	0	1	1	1	0	1	0	126	0	1	1	1	1	1	1	0
93	1	0	1	1	1	0	1	0	127	1	1	1	1	1	1	1	0
94	0	1	1	1	1	0	1	0	128	0	0	0	0	0	0	0	1
95	1	1	1	1	1	0	1	0	129	1	0	0	0	0	0	0	1
96	0	0	0	0	0	1	1	0	130	0	1	0	0	0	0	0	1
97	1	0	0	0	0	1	1	0	131	1	1	0	0	0	0	0	1
98	0	1	0	0	0	1	1	0	132	0	0	1	0	0	0	0	1
99	1	1	0	0	0	1	1	0	133	1	0	1	0	0	0	0	1
100	0	0	1	0	0	1	1	0	134	0	1	1	0	0	0	0	1
101	1	0	1	0	0	1	1	0	135	1	1	1	0	0	0	0	1

2.2.3 Pendant mount

1. Assemble the three parts of wall bracket together as below shows.

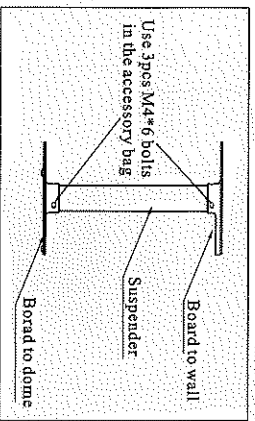

Picture 2.2.3-1

2. Take off the housing, and use 3pcs M4*20 bolts to fasten dome and board, then install the housing back.

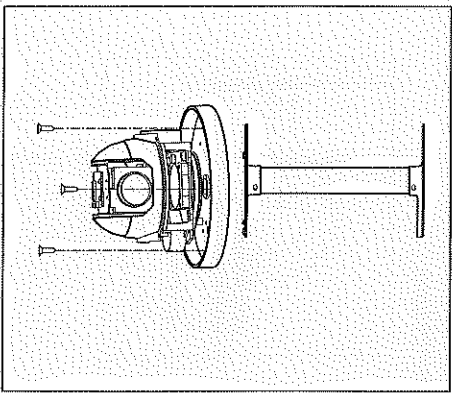

Picture 2.2.3-2

3. Install the wall bracket to the wall by 3pcs STP4*20 bolts.

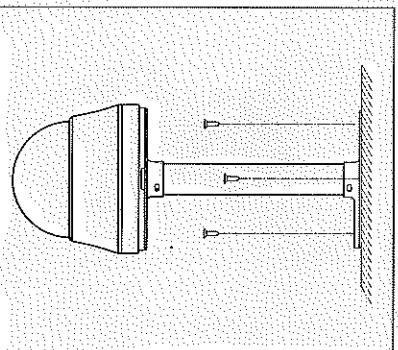

Picture 2.2.3-3

2.3 Outdoor dome installation

2.3.1 Ceiling mount

1. Install the bracket onto the ceiling using 3pcs STP4*20 bolts.

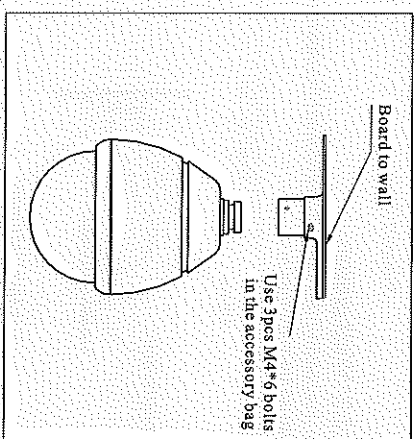

Picture 2.3.1-1

ID	Switch number (Sw)								ID	Switch number (Sw)							
	(Bit)	2	3	4	5	6	7	8		(Bit)	2	3	4	5	6	7	8
1	0	0	0	0	0	0	0	0	34	0	1	0	0	0	1	0	0
2	0	1	0	0	0	0	0	0	35	1	1	0	0	0	1	0	0
3	1	1	0	0	0	0	0	0	36	0	0	1	0	0	1	0	0
4	0	0	1	0	0	0	0	0	37	1	0	1	0	0	1	0	0
5	1	0	1	0	0	0	0	0	38	0	1	1	0	0	1	0	0
6	0	1	1	0	0	0	0	0	39	1	1	1	0	0	1	0	0
7	1	1	1	0	0	0	0	0	40	0	0	0	1	0	1	0	0
8	0	0	0	1	0	0	0	0	41	1	0	0	1	0	1	0	0
9	1	0	0	1	0	0	0	0	42	0	1	0	1	0	1	0	0
10	0	1	0	1	0	0	0	0	43	1	1	0	1	0	1	0	0
11	1	1	0	1	0	0	0	0	44	0	0	1	1	0	1	0	0
12	0	0	1	1	0	0	0	0	45	1	0	1	1	0	1	0	0
13	1	0	1	1	0	0	0	0	46	0	1	1	1	0	1	0	0
14	0	1	1	1	0	0	0	0	47	1	1	1	1	0	1	0	0
15	1	1	1	1	0	0	0	0	48	0	0	0	0	1	1	0	0
16	0	0	0	0	1	0	0	0	49	1	0	0	0	1	1	0	0
17	1	0	0	0	1	0	0	0	50	0	1	0	0	1	1	0	0
18	0	1	0	0	1	0	0	0	51	1	1	0	0	1	1	0	0
19	1	1	0	0	1	0	0	0	52	0	0	1	0	1	1	0	0
20	0	0	1	0	1	0	0	0	53	1	0	1	0	1	1	0	0
21	1	0	1	0	1	0	0	0	54	0	1	1	0	1	1	0	0
22	0	1	1	0	1	0	0	0	55	1	1	1	0	1	1	0	0
23	1	1	1	0	1	0	0	0	56	0	0	0	1	1	1	0	0
24	0	0	0	1	1	0	0	0	57	1	0	0	1	1	1	0	0
25	1	0	0	1	1	0	0	0	58	0	1	0	1	1	1	0	0
26	0	1	0	1	1	0	0	0	59	1	1	0	1	1	1	0	0
27	1	1	0	1	1	0	0	0	60	0	0	1	1	1	1	0	0
28	0	0	1	1	1	0	0	0	61	1	0	1	1	1	1	0	0
29	1	0	1	1	1	0	0	0	62	0	1	1	1	1	1	0	0
30	0	1	1	1	1	0	0	0	63	1	1	1	1	1	1	0	0
31	1	1	1	1	1	0	0	0	64	0	0	0	0	0	0	1	0
32	0	0	0	0	0	1	0	0	65	1	0	0	0	0	0	1	0
33	1	0	0	0	0	1	0	0	66	0	1	0	0	0	0	1	0
									67	1	1	0	0	0	0	1	0

9.5 DIP switch setup

There are two DIP switches on the main board of the dome (see picture 9.4-3). SW1 is for dome address setting, and SW2 is for dome protocol and baud rate setting.

9.5.2 Protocol setup (SW2)

PROTOCOL	SWITCH NUMBER (SW2)				
	(Bit)	1	2	3	4
FACTORY (FACTORY PROTOCOL)	0	0	0	0	0
PELCO	1	0	0	0	0
ERNITEC	0	1	0	0	0
VCL	1	1	0	0	0
MOLYNX	0	0	1	0	0
VICON	1	0	1	0	0
SANTACHI	0	1	1	0	0
PANASONIC	1	1	1	0	0
SAMSUNG	0	0	0	1	0
DIAMOND	1	0	0	1	0
KALATEL	0	1	0	1	0
LILIN	1	1	0	1	0
VIDO B02	0	0	1	1	0
HUNDA	1	0	1	1	0
RESERVED	OTHERS				

9.5.1 Baud rate setup (SW2)

Please according to "Appdiex RS485 Bus Basic knowledge", to check whether baud rate is satisfied with the demand of transmission distance.

In the following list, "1" set DIP as "ON", and "0" set DIP as "OFF".

Baud rate	Switch number(SW2)
	(Bit) 6 7
2400bps	0 0
4800bps	1 0
9600bps	0 1
19200bps	1 1

9.5.3 ID setting (SW1)

In a system, a decoder includes speed dome camera and common decoder, there aren't the same ID between them. The ID switch in decoder and the ID setting of the dome as follow, in the sheet, "1" set DIP switch as "NO", "0" set DIP switch as OFF.

2.3.2 Wall mount

2. Fasten the dome and bracket using 3pcs M4*6 bolts.

1. Install the bracket onto the wall using 3pcs STP4*20 bolts.

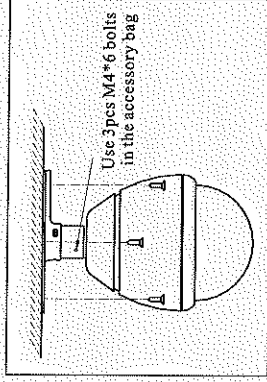

Picture 2.3.1-2

2.3.3 Pendant mount

1. Install the bracket onto the wall using 3pcs STP4*20 bolts.

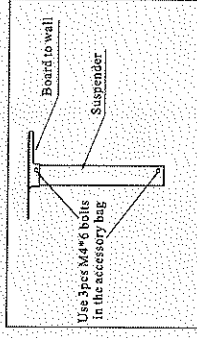

Picture 2.3.3-1

2. Fasten the dome and bracket using 3pcs M4*6 bolts.

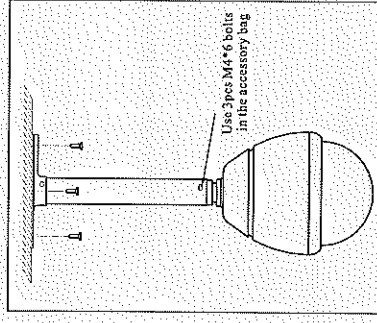

Picture 2.3.3-2

2.3.2 Wall mount

1. Install the bracket onto the wall using 3pcs STP4*20 bolts.

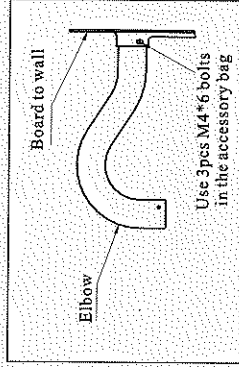

Picture 2.3.2-1

2. Fasten the dome and bracket using 3pcs M4*6 bolts.

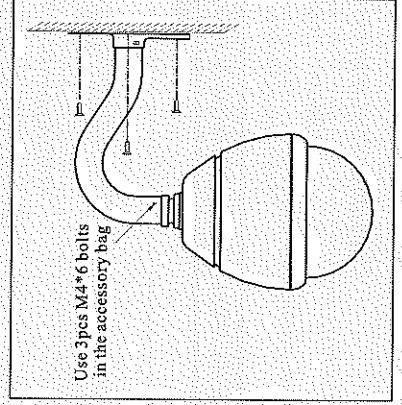

Picture 2.3.2-2

3. Performance

3.1 Technology parameter

Power supply	DC12V	Baud rate (RS485)	2400/4800/9600/19200bps
Consumption	5W	Communication Protocol	Pelco-D, Pelco-P, Samsung, Factory
	Operational	ID setting	0-255
Decoder	Built-in	Physical	
Pan rotation	360°	Operation temp	-10°C ~ +50°C
Tilt rotation	Tilt 90°, with auto-flip	Environmental humidity	0~75%(no condensation)
Rotation speed	Pan:0.2 ~ 300°/s Tilt:0.4 ~ 200°/s	Mount way	Ceiling mount
Preset	128	Gross Weight	1.3kg
Monitor way	Preset/tour/scan/pattern	Material	Aluminum, iron and carbon alloy, plastic

3.2 Camera parameter

Items	Specification
CCD device	SONY1/4" ExView-HAD PS CCD
Total pixel	811 x 508
Effective pixel	768 x 494
Focus length	F=3.6-44.3mm, F1.6(Wide)/F2.0(Tele)
View Angle	Tele:4.64° (H) x 3.52° (V), Wide: 54.44° (H) x 41.42° (V)
Horizontal resolution	560TVLines/600TVLines
Mini illumination	0.0001Lux/F1.6
S/N	≥52dB
Privacy zone	12ea (square)
Day & Night	COLOR/BW/AUTO/EXT(with D/N Filter Assy)
Motion Detection	Off/on(1ea) Mask Area 4ea
High speed shutter	1/60(1/50) - 1/10Ksec
WDR	Off/on (x128/NTSC, x160/PAL)

RS485Bus troubles shooting

Trouble	Possible cause	Solution
Dome can do self-testing but can not be controlled	<ol style="list-style-type: none"> 1. The address and baud rate setting of dome are not in conformity with those of controller. 2. The + and - connection of RS485 Bus is incorrect 3. Bad connection 4. There are circuit in the RS485 Bus. 	<ol style="list-style-type: none"> 1. Change the address and baud rate of controller or dome 2. Adjust the + and - connection of RS485 3. Make sure the connections are fully seated 4. Change RS485 Bus wires
The dome can be controlled but the operation is not smooth	<ol style="list-style-type: none"> 1. The RS485Bus is not in good contact with the connectors 2. One wire of RS485bus is broken 3. The dome is very far from controller 4. There are too many domes connected in the system 	<ol style="list-style-type: none"> 1. Secure the connection 2. Replace RS485 bus wires 3. Add termination resistors to the system 4. Install RS485 distributor

①The connection of 120Ω termination resistor

Connect or disconnect the 120Ω termination resistor by adjusting the eighth bit of the Sw2 on the main board. "1" set as "ON" means connect, and set "0" as "OFF" means disconnect.

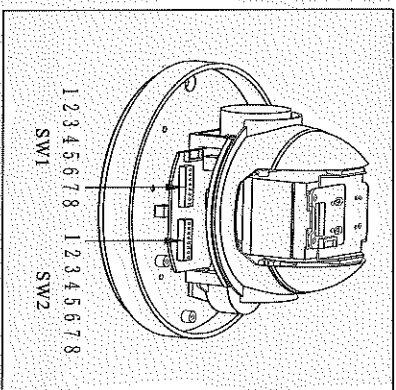

Picture 9-4-5

9.4 RS485Bus basic knowledge

Characteristics of Rs485 Bus

As specified by Rs485 standard, Rs485 Bus is of half-duplexed data transmission cables with characteristic impedance as 120Ω. The maximum load capacity is 32unit loads(including main controller and controller equipment)

Transmission distances of Rs485 Bus

When user selects the 0.56mm(24AWG) twist pair wires as data transmission cable, the maximum theoretical transmitting distance are as follows:

Baud rate	Max distance
2400bps	1800m
4800bps	1200m
9600bps	800m
19200bps	600m

If user selects thinner cables, or installs the dome in an environment with strong electromagnetic interference, or connects lots of equipment to the Rs485Bus, the max transmitting distance will be decreased. To increase the maximum transmitting distance, do the contrary.

Connection and termination resistor

The Rs485Bus standards require a daisy-chain connection between the equipment. There must be termination resistors with 120Ω (as the picture 9.4-1). Please refer to picture 9.4-2 for simple connection. D should not exceed 7m.

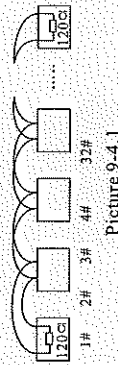

Picture 9.4.1

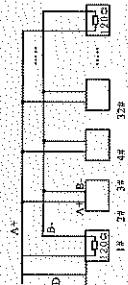

Picture 9.4.2

Problems in practical connections

In some circumstances user adopts a star configuration in practical connection. The termination resistors must be connected to the two equipment 1# and 15# in picture 9.4-3. As the star configuration is not in conformity with the requirements of RS485 standards, problems such as signal reflections, lower anti-interference performance arise when the cables are long in the connection. The reliability of control signals is decreased with the phenomena that the dome does not respond or just responds at intervals to the controller, or does continuous operation without stop.

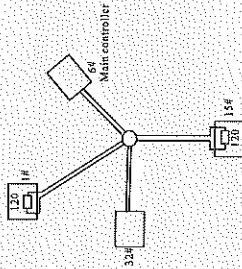

Picture 9.4-3

In such circumstances the factory recommends the usage of RS485 distributor. The distributor can change the star configuration connection to the mode of connection stipulated in the RS485 standards. The new connection achieves reliable data transmission (Refer to Picture 9.4.4).

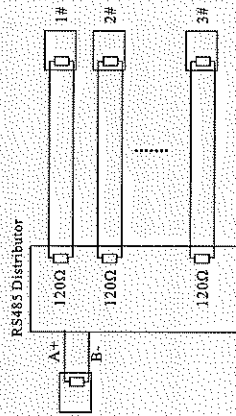

Picture 9.4.4

3.3 Performance and feature

This product is high-technology surveillance product with high definition and color camera, variable-speed pan/tilt and multifunction decoder. It can reduce the connection and installation process between systematic parts at a max limit, and also can improve the stability and reliability of the system. Meanwhile it is easy to install and repair, and it has the following advantages: beautiful shape, rotate lightly and neatly, little noise, simple operation and so on.

1. Built-in digital camera

- High sensitivity, high resolution, and integrated digital processing
- Auto-focus
- Auto-Iris
- Auto brightness control
- Auto white balance
- IR cut filter
- Auto back light compensation
- Auto slow shutter

2. Integrated and multi-protocol decoder

- Figure design, all the data are stored in the inner of camera pan/tilt, when power off, the storage data can't be lose.
- Built-in decoder, integrated multi-protocol, including PELCO-D, PELCO-P, FACTORY, etc.
- 128 presets can be stored, preset 1-80 support auto tour, and each tour can store up to 32 presets.
- 4 pattern, 4 scan, 4tour
- Built-in direction indicator and temperature indicator
- Rs485 bus controlling in series, and dome ID 1-255 optional

3. Built-in pan/tilt

- Iron and carbon alloy structure, high intensity, and good heat dissipation.
- Precise stepping motor, rotates smoothly, react sensitivity and orientate accurately.
- Exquisite mechanical drive, support pan 360° continuously and tilt 0-90° , and may rotate 180° with auto flip.
- Rotate slowly at pan 1° /s, and the image doesn't jitter.

4. OSD menu

- All the menu option are displayed in English.
- Video OSD menu. It is direct and simple to revise the dome information and parameter by keyboard and menu display
- May set park action, and set power up action or carry out appointed action.

5. Internal temperature test

- When the temperature exceeds the upper limit, the screen will display alarm information.
- According to the real-time temperature, the fan will measure if it starts or not, and prolong the life of fan.

4. Function instruction

This passage mainly describes the main function and general principle of mini speed dome, and does not refer to the operation methods.

4.1 Auto-run motion

● Focus/speed proportion pan

When manually adjusting, for far focus situation, the dome responds at a high-speed so that touching rocker slightly may make picture move rapidly, thus cause the picture to lose. To base on humanized design, the dome automatically adjust pan and tilt rotation according to zoom near and far, which make it is convenient to operate manually to make tracks for the object. In the menu, you may change system parameter setting proportion pan as ON, thus you may run this function.

● Auto flip

If user holds the joystick in the down position, the camera rotates pan 180 degrees, then the camera rotates tilts up to 90 degrees, you may directly watch the rear view to realize surveillance all processes in portrait 180 degrees. In the menu, you may set the system parameter setting AUTOFLIP as ON, thus you may run this function.

● Park action

By the menu "park time" and "park action", user may set auto-call preset or run tour, pattern, and scan, etc after pointing a few minutes if the dome doesn't run any motions.

● Power up action

By the menu "power up action", after the dome powers up or restarts, user may set auto-resume motions before power up and auto-call preset or run tour, pattern, and scan etc.

4.2 Camera control

● Magnification control

The user can control "Wide/Tele" to adjust zoom far and near of the image by keyboard controller to obtain panoramic image or close view that you need. The speed dome support digital zoom and optical zoom.

● Focus control

System defaults Auto focus: When the lens changes, camera will auto-adjust focus according to the centre of the image to get legible image; user also can manually focus to get desire image by operating keyboard "FAR/NEAR". When operating keyboard joystick, camera resumes to auto focus.

The camera cannot auto focus in the following status:

- Target is not the centre of the image
- Observation the target near and far at the same time, can not be clear at the same time.
- Target is a strong light object, such as spotlight etc.
- Target moves too fast
- Target is subfusc, such as wall
- Target is too dark or vague
- Target image is too small

9.2 Trouble shooting

Trouble	Possible causes	Solution
No action, no video after power up	Power supply is damage or power consumption is not enough	Replace
	Power line connected wrong	Correct
Self-testing and image are normal but the dome is uncontrollable	Engineering line is malfunction	Check and repair
	The dome DIP switch setting is incorrect	Refer to switch setting, reset the switch
	Rs485 may carve out a way	Check Rs485 connection, confirm the connection is correct and good in contact
Video image is not steady.	Rs485 is in malfunction	Pls consult appendix J [Rs485 Bus acknowledge]
	Video line is bad connection	Eliminate
Video image is not steady and the motor is faulted	Power consumption is not enough	Replace right power adapter, it is better to put the switch and power adapter near the dome
	Power consumption is not enough	Replace the power
Dome controlling is not smooth.	Controlling line connected wrong, or Rs485 loads too much or the distance of communication is too far	1.Connect 120Ω resistance in the dome pan/tilt that is far from the controller 2.Increase distributor

9.3 The cleaning of clear down cover

To obtain constant clear videos, user should clean the down cover periodically.

- Be caution when cleaning, hold the down cover ring only to avoid direct touch to the acrylic down cover. The acid sweat mark of fingerprint will corrode the coating of down cover and scratch on down cover will cause vague image.
- Use soft dry cloth or the substitute to clean the inner and outer surfaces
- For hand contamination, use neutral detergent. Any cleanser for high grade furniture is applicable.

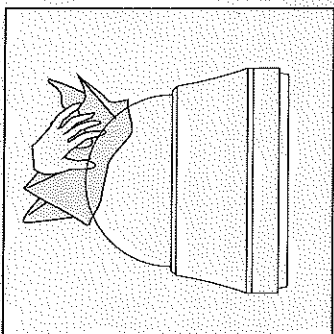

5. System setting

5.1 Basic operation

5.1.1 Power up and self-testing

The dome conducts self-testing after current-carrying and it rotates slowly until displaying pan origin that is default setting, then moving to tilt origin, when self-testing is finished, there is relevant system information displaying on the screen, as follows:

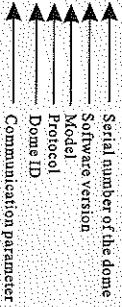
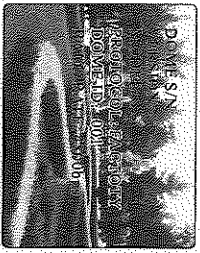

The information will not disappear until you stop to operate the system. If you set "power up action", the dome will automatically activate motions after self-testing. How to operate the function? We will explain detail introduction in following passages.

5.1.2 Call the main menu

The system enters into the main menu by 95preset or twice transfer 9 preset in 3 seconds. All the menu setting must enter into the main menu at first.

5.1.3 Menu and keyboard operation

Ø Keyboard operation:

【OPEN】 when choosing menu, it means to enter the next menu or enter into setting, or save after finish to set.

【CLOSE】 when choosing menu, it means to close to cancel, or exit to the former menu.

Joystick to up: When choosing menu, it means to choose the former one; when choosing picture, it means camera tilt up.

Joystick to down: when choosing menu, it means to choose the next one; when choosing picture, it means camera tilt down.

Joystick to left: when choosing menu, it is equal with **【Close】**, when choosing picture, it means camera tilt left.

Joystick to right: when choosing menu, it is equal with **【Open】**, when choosing picture, it means camera tilt right.

Press **【TELE】** and **【WIDE】** at the same time, it means 3D joystick rotates joystick cap.

Ø Menu operation:

"BACK": Back to the former menu.

"EXIT": Exit to menu

"ON": Open some setting

"OFF": Close some setting

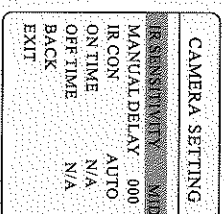
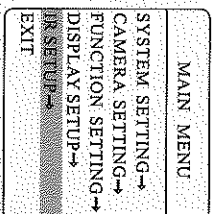

IR SENSITIVITY: The infrared lights automatically opens sensitivity set, LOW MID HIGH three levels, Users can be adjusted according to environmental illumination conditions
IR auto-open

MANUAL DELAY: After manually opening Infrared lamp, Auto-off time, If the time is 0, and said they did not automatically turn off the infrared lamp

IR CON : IR control mode can be divided into AUTO, MANUAL, TIME three modes. In TIME mode, according to the time set by the user IR switch.

In manual mode, adjust NO.62 preset button to turn on the IR LED, turn on NO.63 preset button to turn off the IR LED.

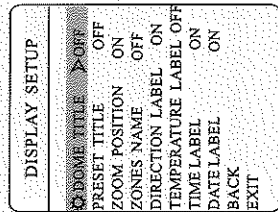
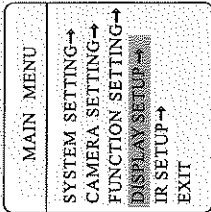

8. Display setup

- The system enters into the main menu by calling 95 preset or by calling 9 preset twice within 3 seconds.
- Operate the joystick up and down and move the cursor to **DISPLAY SETUP**, press **OPEN** to enter menu, to set the content of the display setup as follows:
 - DOME TITLE**
 - PRESET TITLE**
 - ZOOM POSITION**
 - ZONES NAME**
 - DIRECTION LABEL**
 - TEMPERATURE LABEL**
 - TIME LABEL**
 - DATE LABEL**
- Taking display dome title as an example to explain the operation process. Operate up/down joystick to move cursor to **DOME TITLE OFF**, press **OPEN**, there is a sign " " besides **DOME TITLE**, the cursor is twinkling besides **OFF**, as left picture shows.
- Joystick tilts up/down, setting number changes between **ON/OFF**, when setting **ON**, it means to display "dome title". When setting **OFF**, it means not to display "dome title". When pressing **OPEN**, the cursor jump back in front of **DOME TITLE**, which means title setting is finished, when moving the cursor to **EXIT**, it means exiting the menu setting.

The displaying information on the screen will change with the dome rotation. Through the information on the screen, user can see current dome inside temperature, magnification, display zone etc. When all the titles are displayed, the dome works as the following picture shows: (In the picture "305" means pan angle, "45" means tilt angle.)

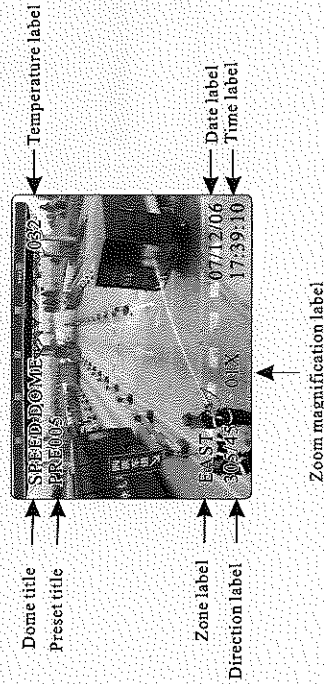

5.2 Edit dome title

When using a lot of systems of the dome, in order to identify to each dome, the systems support title setting. The setting ways as follows:

- Use 95 preset or transfer 9 preset twice in three seconds to enter the main menu.
- Moving joystick up and down to move the cursor to **SYSTEM SETTING** press **OPEN** to enter the next menu.
- Moving joystick up and down to move the cursor to **EDIT DOME TITLE**, press **OPEN** to enter the title setting menu.
- Moving joystick up and down to move the cursor to **TITLE**, press **OPEN** to edit current title.
- When the cursor is twinkling in the first character of the title, to move joystick to choose character, after editing, pressing **OPEN** to save.
- Moving joystick to **BACK**, press **OPEN** to back to the former menu.

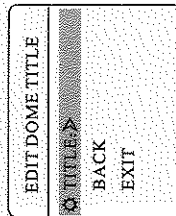
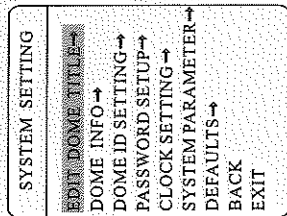
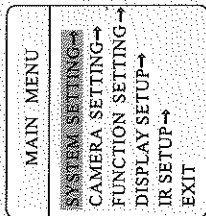



The label may set 16 characters, and doesn't need editing characters. Pressing **OPEN** continuously to jump over and using spacebar to replace the deleted characters. When you finish to edit character, press **OPEN** to enter into the next editing character. When you editing the last character, pressing **OPEN** to save. Notice Press **Close** to exit. Character of label is suitable for choosing as follows: 0-9, A-Z, :<->-, Space.
Other labels' input ways are the same as above.

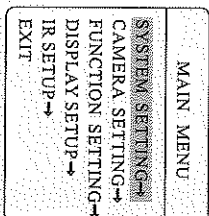

5.3 Dome initial information

1. Use 95 preset or transfer 9 preset twice in three seconds to enter the main menu.
2. Operate the joystick up and down and move the cursor to **【SYSTEM SETTING】**, press **【OPEN】** to enter submenu.
3. Operate the joystick up and down and move the cursor to **【DOME INFO】**, press **【OPEN】** to display initial information as the left picture shows.

Initial information includes S/N of the dome, soft edition, protocol, dome ID, communication parameter. System setting may change the numerical value of initial information.

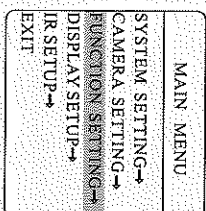
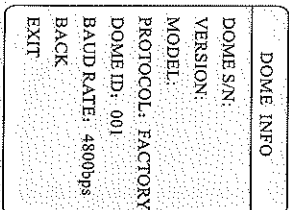
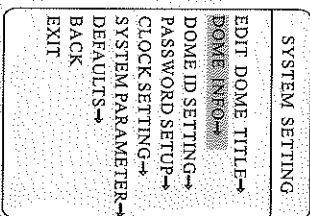

7.5 Zones

Each dome may be set up to 8 zones, and the regional scene can't be overlapped. User will set label for each zone. When setting **【ZONE TITLE】** as ON, the dome will display zone title as it runs some zone. It is convenient to know the zone that the camera shoots by setting zone title.

1. Use 95 preset or transfer 9 preset twice in three seconds to enter the main menu.

2. Operate joystick, move the cursor to **【FUNCTION SETTING】**, press **【OPEN】** to enter submenu.

3. Operate joystick, move the cursor to **【ZONES】**, press **【OPEN】** to enter submenu, as the left picture shows.

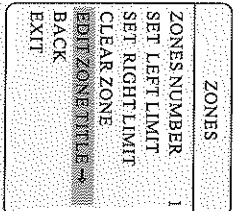
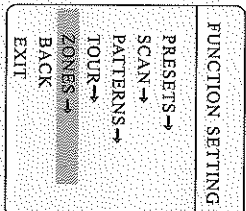

- **【ZONES NUMBER】** choose zone number as current zone, there choices in the menu aim at current zone.
- **【SET LEFT LIMIT】** set current zone's left limit
- **【SET RIGHT LIMIT】** set current zone's right limit
- **【CLEAR ZONE】** clear current zone setting
- **【EDIT ZONE TITLE】** edit current zone title, if zone number is 1, zone title will auto change to ZONE-1

Regard the left/right limit as the demarcation line, and set the middle part as a zone. Various operational ways are the same as other settings in the menu. Therefore we won't explain it again.

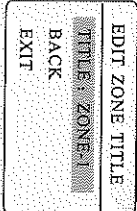

7.4 Tour

Tour is the built-in function in the speed dome, it will arrange the presets into the queue of auto-tour, and can set how long it will park at preset. Operate auto-tour is a process of incessantly transfer each preset. One tour can store 32 presets at most.

1. The system enters into the main menu by calling 95 preset or by calling 9 preset twice within 3 seconds.

2. Operate the joystick up and down and move the cursor to **FUNCTION SETTING**, press **OPEN** enter submenu.

3. Operate the joystick up and down and move the cursor to **TOUR**, press **OPEN** to enter menu "tour".

- **TOUR NUMBER**
- **EDIT TOUR**
- **RUN TOUR**
- **CLEAR TOUR**

4. Set tour: move the cursor to **EDIT TOUR**, press **OPEN** to set tour interface, **PO-S-TM** set preset, speed and time, press **OPEN**, the first dwell is activated, tilt up/down joystick to choose preset number, the preset numerical value should be within 1-80 preset, a tour can set up to 24 presets. Press **OPEN**, the cursor jump to the next dwell, tilt up/down joystick to choose current arrival preset speed, total 8 level of speed, increasingly from level 1 to level 8. Press **OPEN**, the cursor jumps to the next dwell, tilt up/down joystick to set current preset maintaining time, 60 seconds maximum. If set the presets of the second line, move the cursor to the second line, press **OPEN** to continue edit. Press **OPEN** to save after setting, press **CLOSE** to exit.

5. Run tour: Operate joystick, move the cursor to **RUN TOUR**, press **OPEN** to exit the menu, it starts to run tour.

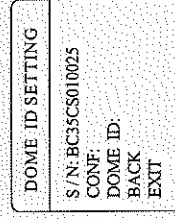
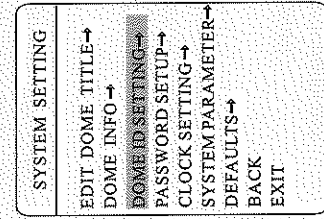
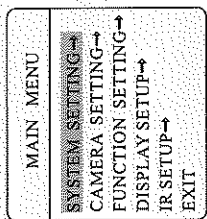
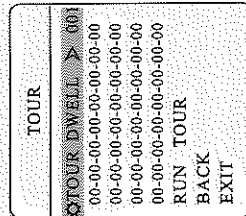
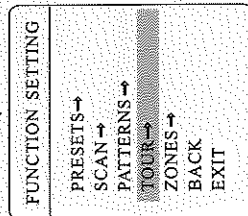
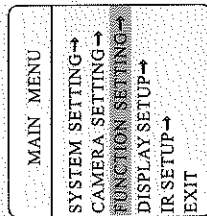

5.4 Dome ID Setting

1. Call 95 preset or call 9 preset twice within 3 seconds, to enter into main menu.

2. Operate the joystick up and down and move the cursor to **SYSTEM SETTING**, press **OPEN** to enter submenu.

3. Operate the joystick up and down and move the cursor to **DOME ID SETTING**, press **OPEN** to call dome parameter setting menu.

S/N: Series number of the dome

CONF: Confirm S/N and input the same number with S/N

DOME ID: Set dome address (ID range: 001-255)

The shortcut of **Dome ID setting**: call 101-116 preset twice within 3 seconds, to set dome ID as 1 to 16. For example, call 103 preset twice within 3 seconds, then dome ID be setted as 3.

1. The dome address should be set as 255 by setting SW1 as ON at first, there will be display this item [DO

NOTICE 2. After setting dome address, the dome need to restart, then the dome address will be effective.

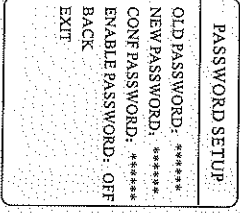
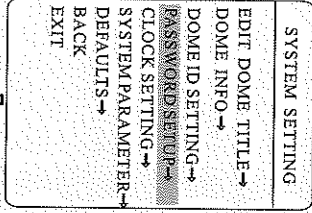
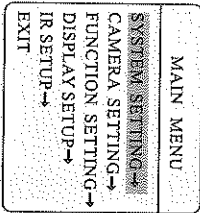

5.5 Password setup

1. Call 95 preset or call 9 preset twice within 3 seconds and then input the password to enter the main menu.
 2. Operate the joystick up and down and move the cursor to **【SYSTEM SETTING】**, press **【OPEN】** to call the submenu.
 3. Operate the joystick up and down and move the cursor to **【PASSWORD SETUP】**, press **【OPEN】** to call the submenu. Please refer to the left picture.
 4. Operate the joystick up and down and move the cursor to **【OLD PASSWORD】**, press **【OPEN】** to choose it, operate the joystick right and left to input the password, up and down to choose the number you need.
 - **【NEW PASSWORD】**: enter the new password
 - **【CONFIRM PASSWORD】**: confirm the new password
 - **【ENABLE PASSWORD】**: set password function ON/OFF
- The password function is effective only "ENABLE PASSWORD" is set as "ON".

NOTICE

When user forgot the password and can not enter into the main menu, he can use the super password to enter, which is "584609", at this time, the password of dome will change to initial one, which is "000000", and then user may set the password by himself again.

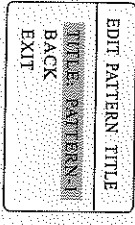
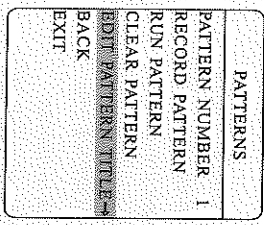
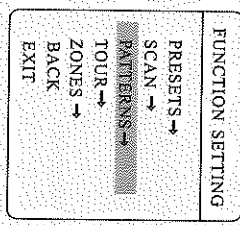
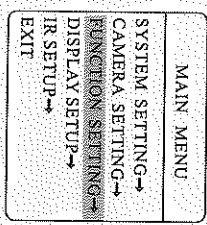

7.3 Pattern

Pattern is built-in function in camera, the speed dome can record tracks that are no less than 180s. (A series of pan/tilt controlling and lens controlling command). Each dome may set up to 4 patterns.

1. The system enters into the main menu by calling 95 preset or by calling 9 preset twice within 3 seconds.
2. Operate the joystick up and down and move the cursor to **【FUNCTION SETTING】**, press **【OPEN】** to enter submenu.
3. Operate the joystick up and down and move the cursor to **【PATTERN】**, press **【OPEN】** to enter menu "Pattern".
 - **【PATTERN NUMBER】**
 - **【RECORD PATTERN】**
 - **【RUN PATTERN】**
 - **【CLEAR PATTERN】**
4. Choose pattern number, move the cursor to **【PATTERN NUMBER】**, press **【OPEN】**, the pattern you choose as current one, the following operations aim at the current pattern.
5. Define current pattern tour: move the cursor to **【RECORD PATTERN】**, press **【OPEN】** to set pattern track, move the image random, and draw the focus. Each dome has a tour that is no less than 180s, a series of park time, magnification, focus will be recorded, press **【OPEN】** to save.
6. Run pattern: operate joystick to **【RUN PATTERN】**, press **【OPEN】** to run, the dome will continuously and repeatedly record the specific track.

NOTICE

When carry out program, run, clear pattern and edit title, should choose pattern number at first.

MAIN MENU
SYSTEM SETTING→
CAMERA SETTING→
FUNCTION SETTING→
DISPLAY SETUP→
IR SETUP→
EXIT



FUNCTION SETTING
PRESETS→
SCAN→
PATTERNS→
TOUR→
ZONES→
BACK
EXIT



SCAN
SCAN NUMBER 1
SCAN SPEED 20
SET LEFT LIMIT
SET RIGHT LIMIT
CLEAR SCAN
RUN SCAN
EDIT SCAN TITLE→
BACK
EXIT



EDIT SCAN TITLE
TITLE: SCAN 1
BACK
EXIT

7.2 Scan

Scan is that pre-set two points , then the camera repeatedly scan between the two points at a stable speed, the same magnification and pan. Each dome has four scan.

1. The system enters into the main menu by calling 95 preset or by calling 9 preset twice within 3 seconds. Click menu to enter "scan" menu, as the left picture shows.

- **【SCAN NUMBER】**
- **【SCAN SPEED】**
- **【SET LEFT LIMIT】**
- **【SET RIGHT LIMIT】**
- **【RUN SCAN】**
- **【CLEAR SCAN】**
- **【EDIT SCAN TITLE】**

2. Define current scan number: operate joystick ,move the cursor to **【scan number】** , press **【open】** , tilt up/down joystick to choose scan number, press **【open】** to save. The following operations aim at the current scan number.

3. Scan speed setting: operate joystick to **【SCAN SPEED】** , press **【OPEN】** , tilt up/down joystick to adjust scan speed, press **【OPEN】** to save.

4. Left limit setting: operate joystick to **【SET LEFT LIMIT】** , press **【OPEN】** , operate joystick to choose objective image, press **【OPEN】** to save. Right limit setting is the same as left limit setting. .

5. Edit scan label: operate joystick, move the cursor to **【EDIT SCAN TITLE】** , press **【OPEN】** to enter submenu "edit title", move the cursor to **【TITLE】** , the system will auto-set the label as SCAN 1, press **【OPEN】** to revise.

NOTICE

The label can set up to 16 characters, and doesn't need editing characters. Pressing **【OPEN】** continuously to jump over and using spacebar to replace the deleted characters. When you finish to edit a character, pressing **【OPEN】** to enter into the next editing character when you finish to edit the last character, pressing **【OPEN】** to save. Press **【CLOSE】** to exit.

Character of label is suitable for choosing as follow: 0-9, A-Z, :<->, Space. The editing ways of other labels are the same as above.

6. Run scan: operate joystick to **【RUN SCAN】** , press **【OPEN】** to exit the menu, and it starts to run scan.

NOTICE

1. left limit and right limit of scan can't be set the same point.
2. Under scan process, speed, magnification and tilt direction won't change, if the speed, magnification and tilt direction of the two limits are inconsistent, run scan is base on left limit.

5.6 Clock setting

1. Call 95 preset or call 9 preset twice within 3 seconds and then input the password to enter into the main menu.

2. Operate the joystick up and down and move the cursor to **【SYSTEM SETTING】** , press **【OPEN】** to call the submenu.

3. Operate the joystick up and down and move the cursor to **【CLOCK SETTING】** , press **【OPEN】** to call the submenu. Please refer to the left picture.

4. Operate the joystick up and down and move the cursor to **【TIME】** , press **【OPEN】** to choose it, move the joystick up and down to choose the number you need, move the joystick right and left to set hour, minute, second.

- **【TIME】** : set hour, minute, second
- **【DATE】** : set year, month, date
- **【DAY】** : set week

MAIN MENU
SYSTEM SETTING→
CAMERA SETTING→
FUNCTION SETTING→
DISPLAY SETUP→
ALARMS SETUP→
IR SETUP→
EXIT



SYSTEM SETTING
EDIT DOME TITLE→
DOME INFO→
DOME ID SETTING→
PASSWORD SETUP→
CLOCK SETTING→
SYSTEM PARAMETER→
DEFAULTS→
BACK
EXIT



CLOCK SETTING
TIME 03:20:18
DATE 07-10-10
DAY WED
BACK
EXIT

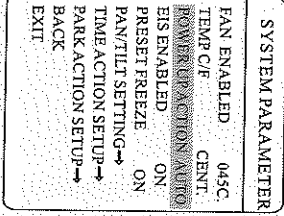
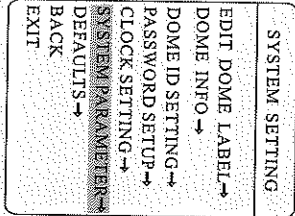
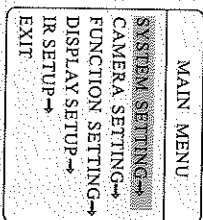

5.7 System parameter

Systematic motion controlling may control a series of canonical movement of the dome, and plays an important role in controlling the image of the dome.

1. The system enters into the main menu by calling 95 preset or by calling 9 preset twice within 3 seconds.
2. Operate the joystick up and down and move the cursor to **SYSTEM SETTING**, press **OPEN** to enter submenu.

5.7.1 Power up action

The dome startup to run actions after self-testing, if nobody intervenes with it, the dome will repeatedly run this action continuously, its default sets as **NONE**.

Operate joystick, move the cursor to **POWER UP ACTION**: press **OPEN** to jump to the following choice, tilt up/down joystick to choose "power up action", press **OPEN** to save.

- **NONE**: none action
- **AUTO**: the dome resumes the primary action and direction before power up.
- **PRESET**: use preset
- **SCAN**: run scan
- **PAT**: run pattern
- **TOUR**: run tour

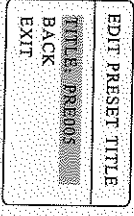
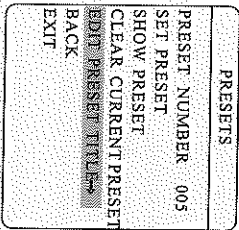
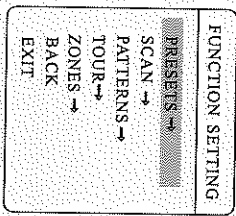
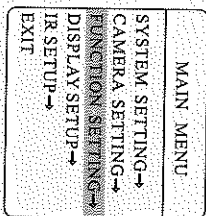

7. Function setting

7.1 Preset

1. The system enters into the main menu by calling 95 preset or by calling 9 preset twice within 3 seconds. Click each command to enter "preset menu" according to the order of the left picture. As follows:

- **PRESET NUMBER**
- **SET PRESET**
- **SHOW PRESET**
- **CLEAR CURRENT PRESET**
- **EDIT PRESET TITLE**

Define preset and call preset function can be set by keyboard operation, input preset number at first, then click the key "save/call preset" to carry out.

2. Define current preset number: move the cursor to **PRESET NUMBER**, press **OPEN** to choose preset number, the range is 01-128 as the left picture shows, here chooses number 5 as current preset, the following operations aim at the current preset.
3. Define current preset: move the cursor to **SET PRESET**, press **OPEN**, by operating joystick to adjust magnification, to choose good objective image, press **OPEN** to save. If the image is very near, the image is belong in digital zoom; when setting preset, the image will jump to maximal optical zoom.

OPERATION KNACKS

Preset function is that dome stores current pan/tilt angle, zoom and other position parameters into the memory. When necessary dome recalls these parameters and adjust camera to that position.

4. Display current preset: move the cursor to **SHOW PRESET**, press **OPEN**, the screen will display the current preset.
5. Clear current preset: move the cursor to **CLEAR PRESET**, press **OPEN**, the current preset is cleared.
6. Edit current preset label: move the cursor to **EDIT PRESET TITLE**, press **OPEN** to enter into editing preset submenu, system auto set title as **PRESET-XX**, press **OPEN** to revise title.



NOTICE When running to program, display, clear preset and edit label, should choose preset number at first.

2. The label may set up to 16 characters, and doesn't need editing characters. Press **OPEN** continuously to jump over and use spacebar to replace the deleted characters. When you finish to edit a character, press **OPEN** to enter into the next editing character; when you finish to edit the last character, pressing **OPEN** to save. Press **CLOSE** to exit. Character of label is suitable for choosing as follow: 0-9, A-Z, <->, space.
3. As the submenu **STATE** in **AUTO TRACKING** is set as OFF, it is valid to Call preset to set auto-tracking ON/OFF. (pls reference the Paragraph 6.7)

MAIN MENU
SYSTEM SETTING →
CAMERA SETTING →
FUNCTION SETTING →
DISPLAY SETUP →
IR SETUP →
EXIT



CAMERA SETTING
LENS PARAMETERS →
AE MODE SETTING →
AWB MODE SETTING →
ADVANCE PARAMETERS →
PRIVACY MASK →
BACK
EXIT



PRIVACY MASK
PRIVACY NUMBER 01
EDIT PRIVACY
ENABLE PRIVACY OFF
CLEAR PRIVACY
BACK
EXIT

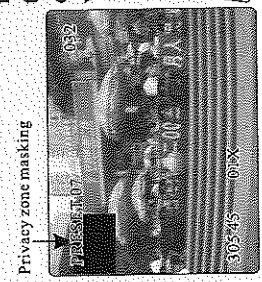

6.5 Privacy zone masking

Privacy function can show someone piece of regional shielding while protecting. For example, protect the window of bedroom or ATM of bank. Each dome can set up to 24 privacy windows. (Masking setting function is relative with the model of camera module. The masking numbers will be different according to the different cameras.)

- The system enters into the main menu by calling 95 preset or by calling 9 preset twice within 3 seconds.
- Operate joystick to **PRIVACY MASK**.
 - PRIVACY NUMBER** choose window number as current privacy window, other choices in the menu just aim at current privacy window
 - EDIT PRIVACY** program current window
 - ENABLE PRIVACY** permit/prohibit current privacy window, there are two choices: ON---permit current privacy window/OFF ---prohibit current privacy window
 - CLEAR PRIVACY** clear current privacy window, after clearing it, the window will auto-change as OFF.
- Program current privacy window: Firstly choose window number, then do the following operations:
 - Operate joystick, move the cursor to **EDIT PRIVACY**, press **OPEN** to move the image that need privacy window to display in the screen.
 - Press **OPEN**, there will be a square displaying in the centre of the screen, operate joystick, and move the square to the central place that need to conceal.
 - Press **OPEN**, operate joystick to adjust the size of privacy zone: joystick to up, the height is increased; joystick to down, the height is reduced; joystick to right, the width is increased; joystick to left, the width is reduced.
 - Press **OPEN** to save the current privacy zone setting, and the window will auto-change as ON at the same time.

NOTICE
This function is decide by the parameter of built-in camera, if the camera does not have this function, this option is invalid.

SYSTEM PARAMETER
FAN ENABLED 040
TEMP C/F
POWER UP ACTION AUTO
EIS ENABLED ON
PRESET FREEZE ON
PAN/TILT SETTING →
TIME ACTION SETUP →
PARK ACTION SETUP →
BACK
EXIT



PAN/TILT SETTING
AUTO FLIP ON
PROPORTION PAN ON
BACK
EXIT

SYSTEM PARAMETER
FAN ENABLED 040
TEMP C/F
POWER UP ACTION AUTO
EIS ENABLED ON
PRESET FREEZE ON
PAN/TILT SETTING →
TIME ACTION SETUP →
PARK ACTION SETUP →
BACK
EXIT



TIME ACTION SETUP
DAY MON
TIME CHANNEL 1
START TIME 00:00
END TIME 00:00
ACTION NONE
BACK
EXIT

5.7.2 PAN/TILT setting

- Operate the joystick up and down and move the cursor to **PAN-TILT SETTING**, press **OPEN** to enter **AUTO FLIP**. Operate the joystick up and down to choose ON to open "auto flip", and choose OFF to close "auto flip". Press **OPEN** to save.

OPERATION KNACKS

When manually adjusting, for far focus situation, the dome responds at a high-speed so that touching rocker slightly may make picture move rapidly, thus cause the picture to lose. To base on humanized design, the dome automatically adjust pan and tilt rotation according to zoom near and far, which make it is convenient to operate manually run after object.

- Operate joystick and move the cursor to **PROPORTIONAL PAN**, press **OPEN** to enter "proportion pan" setting, operate joystick up and down to choose, if choosing **ON**, it means to open proportion pan. If choosing **OFF**, it means to close proportion pan, press **OPEN** to save.

5.7.3 Time action setup

- This setting allows the dome to run an appointed action in the set time in one day.
- Operate the joystick up and down and move the cursor to **TIME ACTION SETUP**, press **OPEN** to set.
- DAY**: set day of the action
 - TIME CHANNEL**: set the time channel
 - START TIME**: start time of the action
 - END TIME**: end time of the action
 - ACTION**: the action you want to run during this time

SYSTEM PARAMETER	
FAN ENABLED	040
TEMP C/F	CENT
POWER UP ACTION	AUTO
EIS ENABLED	ON
PRESET FREEZE	ON
PANTILT SETTING	→
TIME ACTION SETUP	→
PARK ACTION SETUP	→
BACK	
EXIT	



PARK ACTION SETUP	
PARK TIME	005
PARK ACTION	SCAN
BACK	
EXIT	

5.7.4 Park action setup

This setting allows the dome to run an appointed action after it enters vacancy for a few time (1-240minutes). If default sets as 0, it means not to run this action.

1. Operate the joystick up and down and move the cursor to **【PARK ACTION SETUP】**, press **【OPEN】** to tilt up/down joystick to set park time, the range is 0-240 (minute), press **【OPEN】** to save. **【PARK ACTION】** is running action at park time, when **【PARK TIME】** sets as 0, this item can't be set.

2. Operate the joystick up and down and move the cursor to **【PARK ACTION】**, press **【OPEN】** there will be a sign "⚙" in the front of **【PARK ACTION】**; the cursor jump to right, after tilting up/down joystick to choose "park action", there are options: for choosing as follows, press **【OPEN】** to save.

- **【NONE】**: (default) no action
- **【PAT】**: run pattern
- **【TOUR】**: run tour
- **【SCAN】**: run scan
- **【PRESET】**: use preset

MAIN MENU	
SYSTEM SETTING	→
CAMERA SETTING	→
FUNCTION SETTING	→
DISPLAY SETUP	→
IR SETUP	→
EXIT	



CAMERA SETTING	
LENS PARAMETERS	→
AE MODE SETTING	→
AWB MODE SETTING	→
ADVANCE PARAMETERS	→
BACK	
EXIT	



ADVANCE PARAMETERS	
SHARPNESS	05
HI-RESOLUTION	ON
MAX GAIN	28dB
EXPOS COMP	N/A
BACK	
EXIT	

6.4 Advance parameters

1. The system enters into the main menu by calling 95 preset or by calling 9 preset twice within 3 seconds. Move the cursor to **【CAMERA SETTING】** to enter **【ADVANCE PARAMETERS】**.

2. **【SHARPNESS】**: change the sharpness of the image. The value is bigger, the image will be clearer.

3. **【HI-RESOLUTION】**: high resolution is built-in function of camera. This function is relative with the model of camera.

4. **【MAX GAIN】**: it is the max gain of auto gain, and can be set between 8-28dB. When the light is very dark, the value is smaller, the noise of image will be less. The value is larger, the noise of image will be more.

5. **【EXPOS COMP】**: exposal compensation function.

MAIN MENU
SYSTEM SETTING →
CAMERA SETTING →
FUNCTION SETTING →
DISPLAY SETUP →
IR SETUP →
EXIT



CAMERA SETTING
LENS PARAMETERS →
AE MODE SETTING →
AWB MODE SETTING →
ADVANCE PARAMETERS →
PRIVACY MASK →
BACK
EXIT



AWB MODE SETTING
AWB MODE AUTO
R GAIN N/A
B GAIN N/A
BACK
EXIT

6.3 White balance mode

System supports **【AUTO】**, indoor mode **【INDOOR】**, outdoor mode **【OUTDOOR】**, auto track mode **【ATW】**, single mode **【OPW】**, **【OPT】** mode, manual mode **【MANUAL】** and kinds of white balance modes, etc. Detailed setting as follows:

1. The system enters into the main menu by calling 95 preset or by calling 9 preset twice within 3 seconds. Move the cursor to **【CAMERA SETTING】** to enter submenu.

2. Operate the joystick up and down and move the cursor to **【AWB MODE SETTING】**, **【AUTO】** is the default mode of speed dome, which is auto-revert real color after the white balance sensor check the environment by camera. When choosing manual mode **【MANUAL】**, adjust the numerical value of **【R GAIN】** and **【B GAIN】**.

● **【R GAIN】** the range is 1-225, the numerical value is bigger, it means that adding red is more, the tone changes to be warm.

● **【B GAIN】** the range is 1-225, the numerical value is bigger, it means that adding green is more, the tone changes to be cold.

Indoor mode **【INDOOR】** and the tone leans to cold.

Outdoor mode **【OUTDOOR】**, and the tone leans to warm.



NOTICE

It is possible that some cameras do not have the setting of **【INDOOR】**, **【OUTDOOR】**, **【HI-RESOLUTION】**, which means the current camera does not have such function when the setting option shows N/A.

5.8 Defaults

1. The system enters into the main menu by calling 95 preset or by calling 9 preset twice within 3 seconds.

2. Operate the joystick up and down and move the cursor to **【SYSTEM SETTING】**, press **【OPEN】** to enter submenu.

3. Operate the joystick up and down and move the cursor to **【DEFAULTS】**, press **【OPEN】** to enter submenu, as left picture shows.

- **【CLEAR ALL ZONES】**
- **【CLEAR ALL PRESETS】**
- **【CLEAR ALL PATTERNS】**
- **【CLEAR ALL TOURS】**
- **【CLEAR ALL PRIVACIES】**
- **【FACTORY DEFAULTS】** : resume the factory default.

Run this function, the camera parameter and system parameter will resume before production, clear all windows and alarm setting. Please be cautious to use this function.

- **【RESTART】** : restart the dome

4. Set clear zone as an example to explain the process. Tilt up/down joystick to **【CLEAR ALL ZONES】**, press **【OPEN】** to clear all zones.



NOTICE

Once clear all commands in the controlling menu, they don't resume, so please be careful of using.

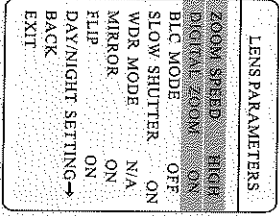
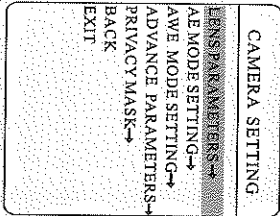
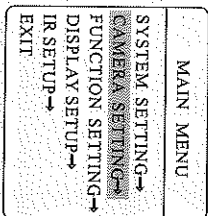

6. Camera setting

6.1 Lens parameters

6.1.1 Zoom speed

1. The system enters into the main menu by calling 95 preset or by calling 9 preset twice within 3 seconds.
2. Operate the joystick up and down and move the cursor to **【CAM-ERA SETTING】**, press **【OPEN】** to enter submenu.
3. Operate the joystick up and down and move the cursor to **【LENS PARAMETERS】**, press **【OPEN】**, the cursor moves to **【ZOOM SPEED】**, tilt up/down joystick to choose **【HIGH】** or **【LOW】**.
4. Press **【OPEN】** to save, press **【CLOSE】** to cancel.

6.1.2 Digital zoom control

1. The system enters into the main menu by calling 95 preset or by calling 9 preset twice within 3 seconds.
2. Operate the joystick up and down and move the cursor to **【CAMERA SETTING】**, press **【OPEN】** to enter camera setting.
3. Operate the joystick up and down and move the cursor to **【DIGITAL ZOOM】**, press **【OPEN】** to enter digital zoom setting, tilt up/down joystick, to choose ON means open digital zoom control which is digital zoom is pulled near, if pulling the digital zoom near again, the dome enters into "digital zoom increase", to choose OFF means to close digital zoom control.
4. Press **【OPEN】** to save.

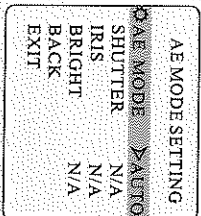
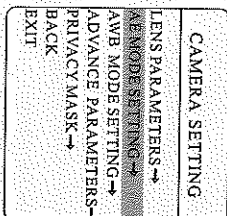
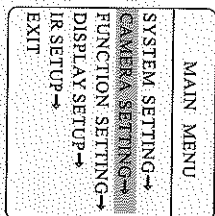

6.2 AE mode

1. The system enters into the main menu by calling 95 preset or by calling 9 preset twice within 3 seconds.
2. Operate the joystick up and down and move the cursor to **【CAM-ERA SETTING】** to enter submenu.
3. Operate the joystick up and down and move the cursor to **【AE MODE SETTING】**, press **【OPEN】**, tilt up/down joystick to choose AE mode, modes for choosing as follows:
 - **【AUTO】**: default setting, auto Iris mode
 - **【SHUTTER】**: shutter priority mode
 - **【IRIS】**: iris priority mode
 - **【BRIGHT】**: brightness priority mode
4. Choose iris priority mode **【IRIS】**, press **【OPEN】** to save.
5. Move joystick to the sub-choices of AE mode **【IRIS F1.4】**, press **【OPEN】** to choose adequate Iris, press **【OPEN】** to save.
 - **【SHUTTER 1/50】** it means shutter speed, when AE mode is shutter priority, this function can be set.
 - **【IRIS F1.4】** it means the size of iris, when AE mode is iris priority, this function can be set.
 - **【BRIGHT F2.0/ODB】** it means brightness, when AE mode is brightness priority, this function can be set.

OPERATION KNACKS

Quality of photo relates to exposure amount, that is to say how much light can make CCD receives legible image. Exposure amount is relative to the time of lighten (be up to shutter speed) and the area of lighten (be up to the size of iris).

The camera can automatically calculate suitable exposure amount according to brightness of scenery and CCD sensitivity, in the situation that the exposure amount is certain. **【SHUTTER】** (shutter priority) is to fix shutter speed, the camera will auto decide to use how much iris, **【IRIS】** (iris priority) is to fix the size of iris, and auto-decide to use shutter speed. **【BRIGHT】** (brightness priority) is point that the camera TTL check the light directly and control the brightness of image.

MAIN MENU
SYSTEM SETTING →
CAMERA SETTING →
FUNCTION SETTING →
DISPLAY SETUP →
IR SETUP →
EXIT



LENS PARAMETERS
ZOOM SPEED > HIGH
DIGITAL ZOOM ON
BLC MODE OFF
SLOW SHUTTER ON
WDR MODE N/A
MIRROR ON
FLIP ON
DAY/NIGHT SETTING →
BACK
EXIT



DAY/NIGHT SETTING
DAY/NIGHT TIME
DAY TIME 00:00
NIGHT TIME 00:00
THRESHOLD 10dB
BACK
EXIT

6. 1. 6 Day/night setting

- The system enters into the main menu by calling 95 preset or by calling 9 preset twice within 3 seconds.
- Operate the joystick up and down and move the cursor to **【CAMERA SETTING】** to enter submenu.
- Operate the joystick up and down and move the cursor to **【LENS PARAMETERS】**, press **【OPEN】** to enter **【DAY/NIGHT SETTING】**, the cursor jumps to right, there are three choices of "DAY/NIGHT", which is as follows:
 - 【AUTO】**: IR cut filter mode, it means the dome automatically transfers according to sensitivity.
 - 【TIME】**: set the time of opening IR cut filter
 - 【COLOR】**: set as color mode
 - 【BLACK】**: set as black and white mode
- 【THRESHOLD】**: sensitive of IR cut filter, the range from 0 to 28dB.
- Press **【OPEN】** to save.

OPERATION KNACKS

IR cut filter function uses color in day; use black and white at night. This function not only guarantees the quality of image, but also saves the room of storage.



NOTICE This function depends on the models and parameters of built-in camera in dome, if the camera haven't this function, then this function is invalid. (N/A)

6. 1. 3 Back light compensation

- The system enters into the main menu by calling 95 preset or by calling 9 preset twice within 3 seconds.
- Operate the joystick up and down and move the cursor to **【CAMERA SETTING】** to enter **【LENS PARAMETERS】**.
- Operate the joystick up and down and move the cursor to **【BLC MODE】**, press **【OPEN】**, there will be a sign "☼" in the front of **【BLC MODE】**, the cursor jump to right, tilt joystick to open or close back light compensation function. If choose OFF means to close back light compensation mode. If choose ON means to open back light compensation mode.
- Press **【OPEN】** to save.

OPERATION KNACKS

Strong background ray can make backlighting objects engender shadow, (back light compensation), the speed dome can auto-adjust iris to match with the changes of various ray, and auto-revise the main lightness to make the pictures more legible.



NOTICE This function relates to models and parameters of the built-in camera in the dome, when open black compensation, it has two functions which are auto-adjust (when you choose ON) or manual adjust(0-255) according to the different of the camera.

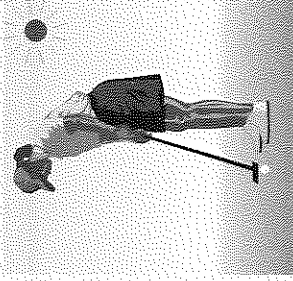

Non-use back light compensation, in strong sunshine, the back light side is subject to dark.

Use back light compensation, the image is in gear.

MAIN MENU
SYSTEM SETTING→
CAMERA SETTING→
FUNCTION SETTING→
DISPLAY SETUP→
IR SETUP→
EXIT



CAMERA SETTING
LENS PARAMETERS→
AE MODE SETTING→
AWE MODE SETTING→
ADVANCE PARAMETERS→
PRIVACY MASK→
BACK
EXIT



LENS PARAMETERS	
ZOOM SPEED	HIGH
DIGITAL ZOOM	ON
BLC MODE	OFF
SLOW SHUTTER	ON
WDR MODE	N/A
MIRROR	ON
FLIP	ON
DAY/NIGHT SETTING→	
BACK	
EXIT	

6.1.4 Slow shutter control

1. The system enters into the main menu by calling 95 preset or by calling 9 preset twice within 3 seconds.
2. Operate the joystick up and down and move the cursor to **【CAMERA SETTING】** to enter submenu.
3. Operate the joystick up and down and move the cursor to **【LENS PARAMETERS】**, press **【OPEN】** to enter **【SLOW SHUTTER】**, there will be a sign "⚙️" in the front of **【SLOW SHUTTER】**, the cursor moves to right, tilt up/down joystick to "slow shutter" choice, if choosing **ON** means to open slow shutter function, if choosing **OFF** means close "slow shutter" function.
4. Press **【OPEN】** to save.

OPERATION KNACKS

When the dome monitors at night or dark environment, because the ray is not enough, the image on the screen is too dark, setting slow shutter can lengthen the time of lighting so that make the picture that is shoot in dark more legible.

 This function depends on the models and parameters of built-in camera module in dome, if it does not have this function, then this function will be invalid.

MAIN MENU
SYSTEM SETTING→
CAMERA SETTING→
FUNCTION SETTING→
DISPLAY SETUP→
IR SETUP→
EXIT



CAMERA SETTING
LENS PARAMETERS→
AE MODE SETTING→
AWE MODE SETTING→
ADVANCE PARAMETERS→
PRIVACY MASK→
BACK
EXIT



LENS PARAMETERS	
ZOOM SPEED	HIGH
DIGITAL ZOOM	ON
BLC MODE	OFF
SLOW SHUTTER	ON
WDR MODE	N/A
MIRROR	ON
FLIP	ON
DAY/NIGHT SETTING→	
BACK	
EXIT	

6.1.5 WDR Control

Operate joystick and move the cursor to **【WDR MODE】**, press **【OPEN】**, tilt up/down joystick to set WDR. Choose **ON** means open WDR, choose **OFF** means close WDR, press **【OPEN】** to save.

【WDR MODE】: WDR is the function that features of image can be captured clearly by camera while the picture was cover with strong contrast background. For example: you can enable WDR function to sublime image quality when the two areas A and B exist simultaneously, A: High intensity area under strong light exposure (source from daylight, lamp and so on), B: Low luminance area, like shadow, backlighting zone and so on.

 This function is relative with the model and parameter of the camera module which insert in the dome. The option is useless(N/A)when the camera module has nosuch function.

4. **【MIRROR】**: image mirroring function.
5. **【FLIP】**: 180° inversion imaging function of image.